

LD38S & LD38C

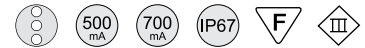

Exterior High Power Linear Lensed LED Surface Grazer and Flood Light

Data sheet - Page 1

New LD38 has been redesigned with an easy clean glass cover, which offers increased lumen output and quicker production times. It is an exterior rated, high power surface grazer that offers superb continuous wall washing capabilities. The compact minimal design and RAL finish option enables it to blend into most project styles. It offers great flexibility to the designer with a range of options that suit most design details and applications; available in custom lengths up to 2.1m; optics for wall washing or flood lighting; a range of colour temperatures including RGBW and Tunable White; various mounting options, finishes and accessories. These coupled with the latest in LED technology make LD38 the perfect choice for illuminating an entire external project.

Key Features

- Superb continuous wall washing capabilities
- Very high power for surface grazing or flood lighting
- Compact, minimal design
- High efficiency optics specially designed for LightGraphix
- LED spacing of 50, 75 and 100mm
- Spacing is maintained across multiple lengths, so no dark spots!
- Wide range of fixing options
- Short pieces can be made interlinked to accommodate curves
- Lengths are custom made to suit to a maximum of 2.1 metres
- Available with Switched, 0-10V, DMX or Dali drivers

Specification

Applications



Beam Angles

12°, 31°, 48°, 36° X 12°

LED type

Cree XPG2

Colour temperature

2700K** / 3000K | 5000K

Drive Current (mA)	500	700	500	700
LED power* (W)	1.7W	2.4W	1.7W	2.4W
CRI (typical)	93	93	75	75
Forward voltage (V) ₁₀₀	3.2V	3.4V	3.2V	3.4V
LED spacing	Delivered lm/m** (L ₁₀₀)			
50mm	2960	3920	3596	4763
75mm	1924	2548	2338	3096
100mm	1480	1960	1798	23581
Lumens per circuit watt***	87	82	106	99

LED lifetime (to 70% lumen maintenance) 50,000hrs at a max ambient temperature of 35°C (if specifying fitting in ambient temperatures of up to 45°C run at 500mA max, LD38-500)

Glass

4mm thick low iron glass

Materials

Silver anodised aluminium body & end caps

Wiring

Comes pre-wired with 2m lead, can be specified with up to 10m at extra cost

IP rating

IP67

*LED wattage includes losses associated with using an 85% efficient driver

** 2700K lumen output is 12% lower than the 3000K figure listed

4000K lumen output is 14% higher than the 3000K figure listed (80 CRI)

***Data shown allows for 50mm spacing

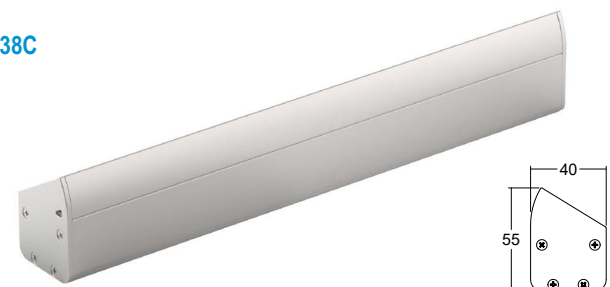
**LD38S****LD38C**

LD38S & LD38C



Exterior High Power Linear Lensed LED Surface Grazer and Flood Light

Data sheet - Page 2

Made to measure

Custom made lengths as standard allow the designer to specify exactly the length they require. Spacing is maintained across multiple lengths, so no dark spots!

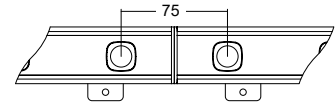
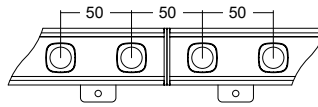
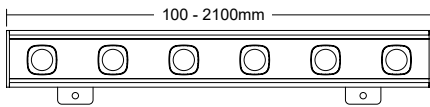

Finishes and materials

LD38 has been designed for extreme environments, so only high quality materials and finishes are used to ensure long lasting reliability. All parts are silver anodised to a minimum thickness of 25 microns which offers high protection in all external environments. RAL external paint finishes are also available and allow the LD38 to blend into the surrounding architecture.

/Silver anodised



/Paint finish Black/White/RAL



LD38S & LD38C



Exterior High Power Linear Lensed LED Surface Grazer and Flood Light

Data sheet - Page 3

Fixing Options and Dimensions

/ABM

Surface Adjustable Bracket Mounting

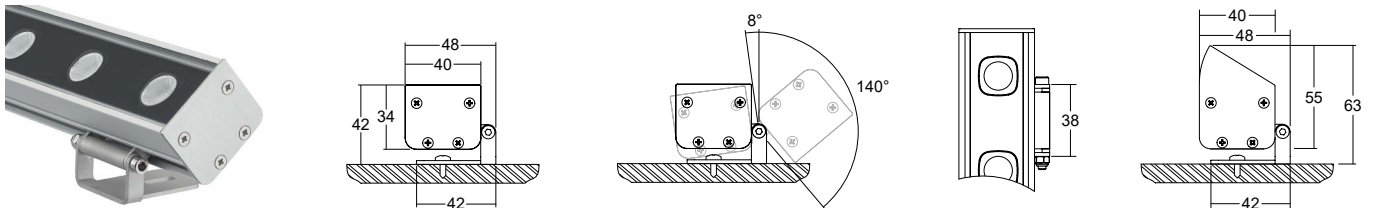

/BSM

Bracket Side Mounting

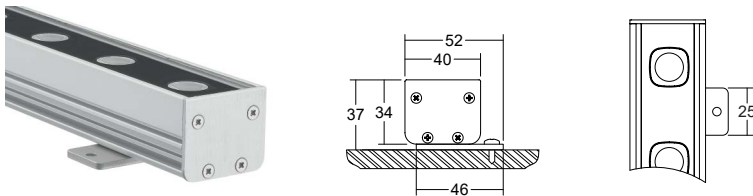

/AWB-50

Adjustable Wall Bracket 50mm

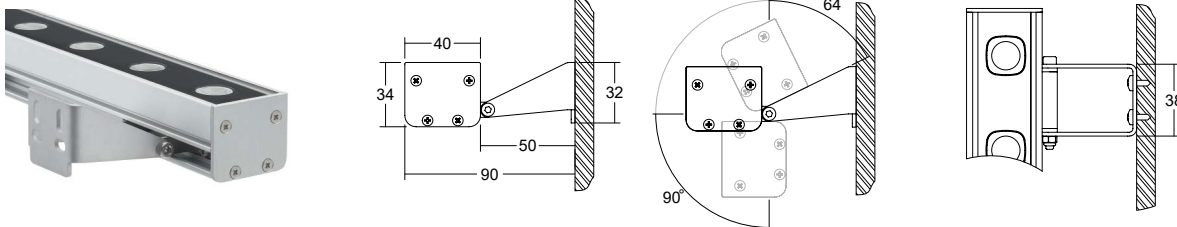

/AWB-300

Adjustable Wall Bracket 300mm
(for custom dimensions please contact us)

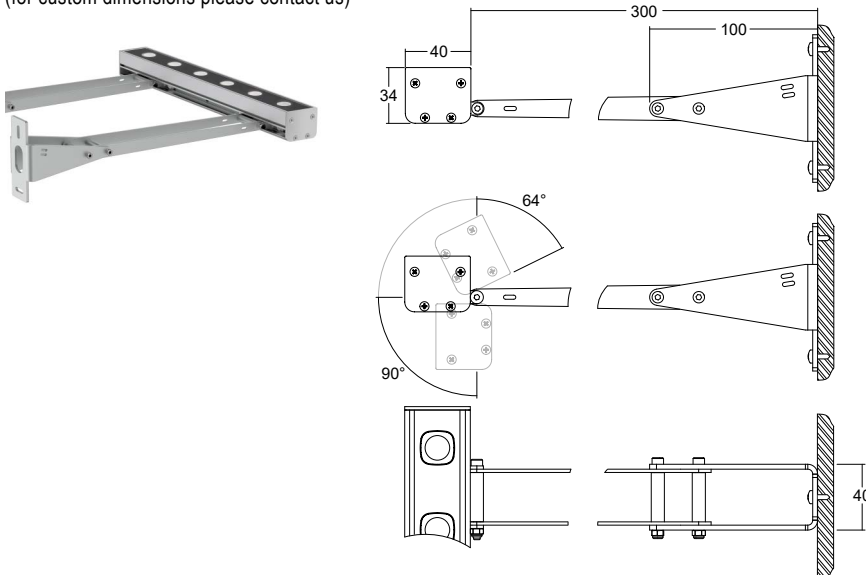

LD38S & LD38C



Exterior High Power Linear Lensed LED Surface Grazer and Flood Light

Data sheet - Page 4

Fixing Options and Dimensions

/GS

The ground spike accessory enables the use of the LD38 as an innovative alternative to conventional spotlights. It offers linear lighting to a range of landscape and garden lighting effects. Ideal for lighting hedge rows, walls and short pieces to light around trees. It can be specified with wider LED spacing to suit the budget or light output needed.

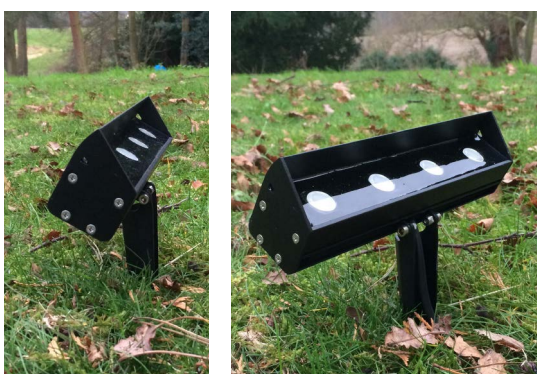
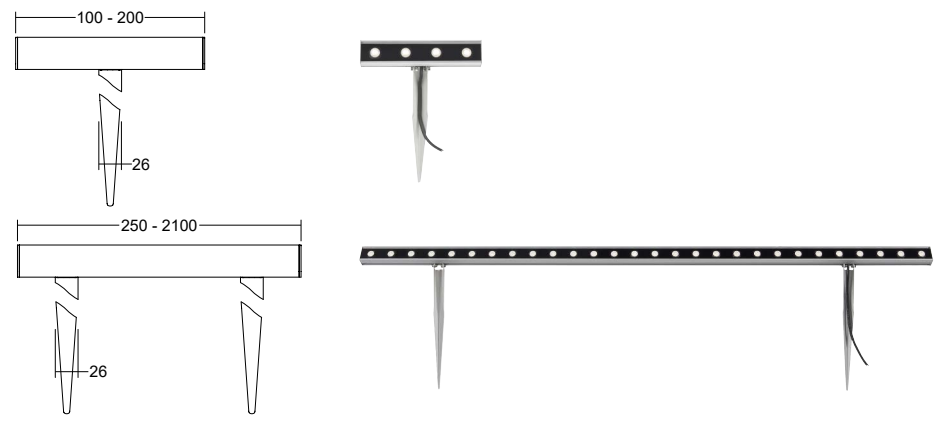

LD38S & LD38C



Exterior High Power Linear Lensed LED Surface Grazer and Flood Light

Data sheet - Page 5

Applications and Mounting Option Guide

LD38 is incredibly versatile, allowing it to be used to illuminate an entire external project. From high power wall grazing, window reveals, floodlighting and landscape illumination there is a fixing accessory and specification to suit. The made to measure lengths allow the designer to create the exact effect they want to achieve in a particular detail. If we don't have the fixing/accessory you want please get in touch.

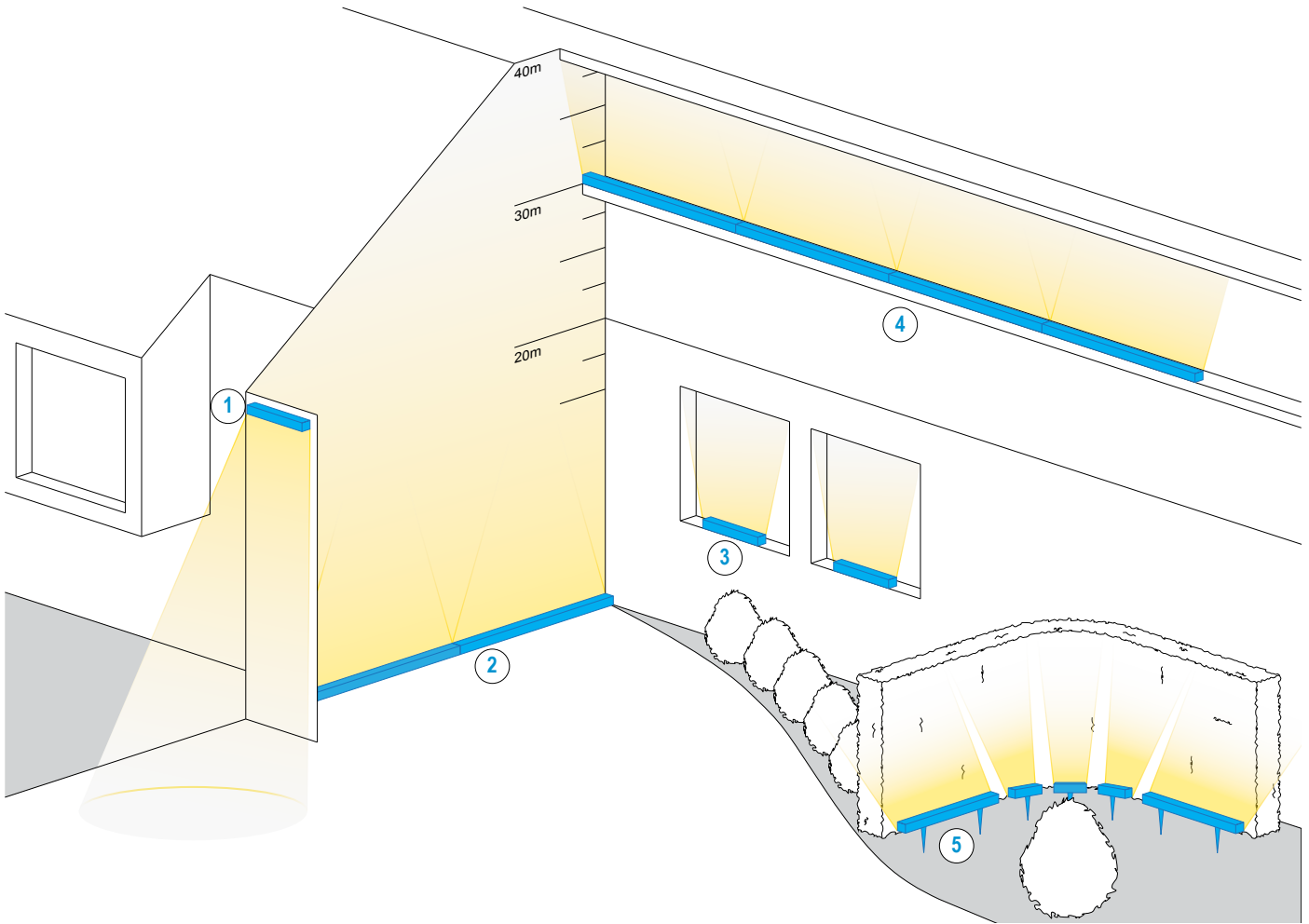

Mounting options:

1

/AWB-50



/AWB-300



2

/AWB-50



/AWB-300



3

/ABM



/BSM



4

/ABM



/BSM



5

/GS



LD38S & LD38C



Exterior High Power Linear Lensed LED Surface Grazer and Flood Light

Data sheet - Page 6

Linked

LD38 can be specified in short sections linked together for going around curves and lighting up columns. Two channels can be used to provide up to 28 LEDs at 500mA or 26 at 700mA.

Design Advice

This section provides advisory module quantities and lengths to ensure drivers are used to their full potential. Custom module and link lengths can be specified.

LED spacing	Module length	No. of modules
350mA / 500mA		
50mm spacing	200mm (4 LEDs)	There is a maximum of 28 LEDs on 2 channels, resulting in 7 modules of 4 LEDs.
75mm spacing	300mm (4 LEDs)	
700mA		
50mm spacing	200mm (4 LEDs)	There is a maximum of 26 LEDs on 2 channels, resulting in 6 modules of 4 LEDs.
75mm spacing	300mm (4 LEDs)	

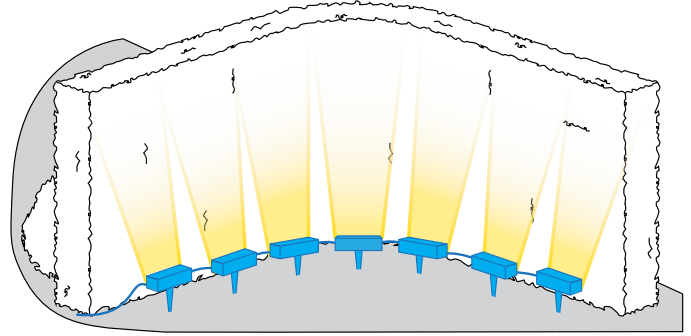

Specifying the LD38 Linked

Using the order codes and options table specify the fittings output, LED colour, LED spacing, beam, finish and mounting method. Then use the guide below to specify the individual modules. See example code and image below.

①	Feed length	Module length	Linked length	Quantity
	Linked starter - 2m	150mm	100mm	1
②		Module length	Linked length	Quantity
	Linked middle -	150mm	100mm	2
③		Module length	Quantity	
	Linked end -	150mm	1	

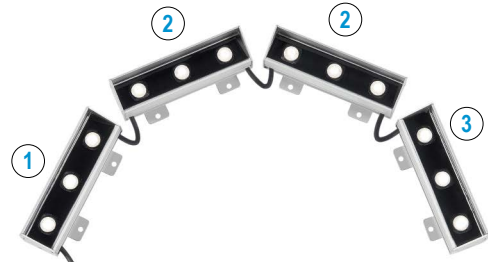

Note: Standard linked cable length - 100mm.

The following is an example code of how the code is broken down if an exact length is specified.

Specification: LD38-700 / LW30 / 50 / OB / White / AWB-50 / IP67 / CO

Example: 2025mm required = 1 x 300mm linked starter, 5 x 300mm linked middle, 1 x 225mm linked end

Accessories

/GL

Anti glare louvre. Please note this is always supplied in black finish, and is supplied as standard with the louvre positioned to reduce glare when looking at the lit surface. The GLF orientation is useful for applications where the LD38 is placed on a window ledge and reduced glare is required from inside the building looking out.

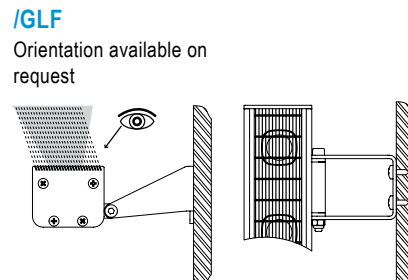
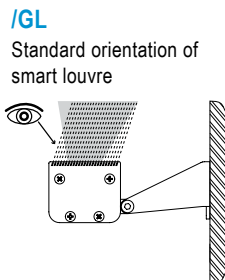

LD38S & LD38C

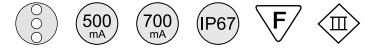

Exterior High Power Linear Lensed LED Surface Grazer and Flood Light

Data sheet - Page 7

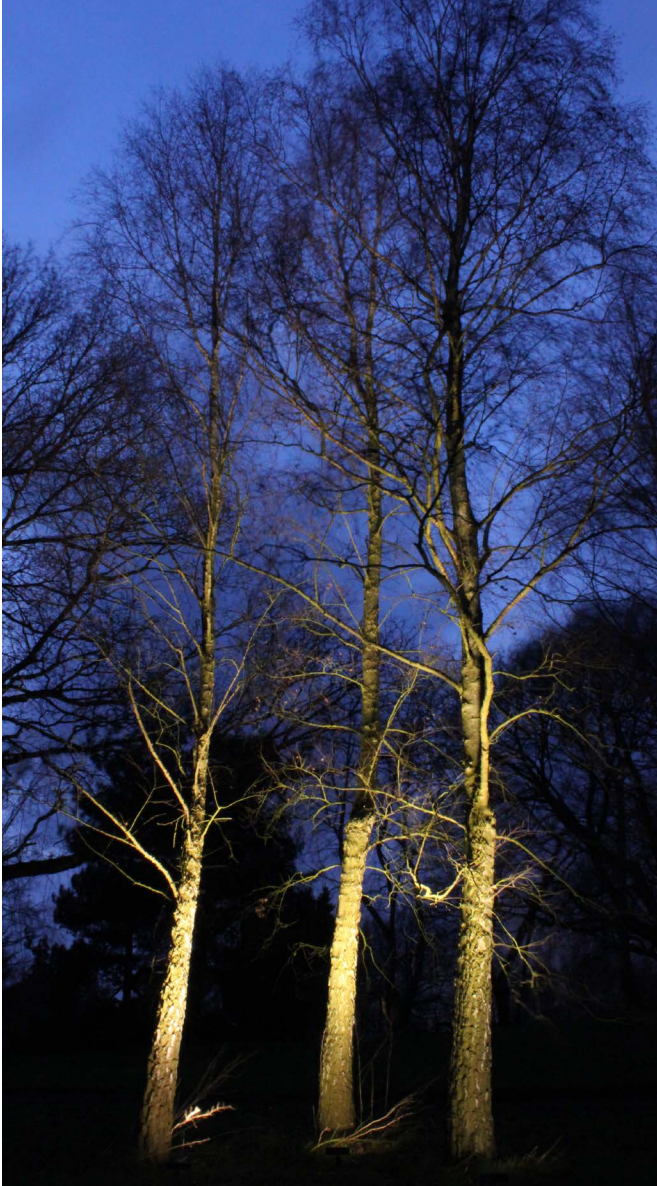

Photometrics

Photometric files can be downloaded from the LD38 product page on the website.

Order Codes and Options

Product code	LED colour	LED spacing	Beam angle	Fitting colour	Fixing option	Accessory	Length
LD38 - 500 - 700	<input type="text"/>	<input type="text"/>	<input type="text"/>	<input type="text"/>	<input type="text"/>	<input type="text"/>	<input type="text"/>

Example: LD38S-700 / LW30 / 50 / OB / White / AWB-50 / GL / 500mm

Product codes with output options

LD38S (without cowl)	
1.7W LED at 500mA	LD38S-500
2.4W LED at 700mA	LD38S-700
LD38C (with cowl)	
1.7W LED at 500mA	LD38C-500
2.4W LED at 700mA	LD38C-700

LED colour options

Extra Warm White (2700K)	/LW27
Warm White (3000K)	/LW30
White (4000K) - on request	/LW40
Cool White (5000K)	/LW50
Red	/LR
Blue	/LB
Green	/LG
Amber	/LA

LED spacing

50mm	/50
75mm	/75
100mm	/100

Beam / lens angle options

12° narrow spot	/NB
31° medium	/MB
48° wide	/WB
36° x 12° oval beam	/OB

Product colour

Silver - End caps, extrusion and fixings (silver anodised)
 Black - End caps, extrusion and fixings (black powder coat)
 White or RAL - End caps, extrusion and fixings (paint finish)

Fixing options

Adjustable wall bracket (50mm)	/AWB-50
Adjustable wall bracket (300mm)	/AWB-300
Surface mounted bracket	/ABM
Bracket side mounting	/BSM
Ground spike	/GS

Accessory

Anti glare louvre	/GL
Anti glare louvre (front facing)	/GLF

Use with 350mA, 500mA and 700mA constant current LED drivers

We have a wide range of dimmable LED drivers, 0-10V, DMX, DALI and Mains dimmable. Please see the downloads section on our website